

# CM-1 MANUAL



**TABLE OF CONTENTS**

GENERAL INFORMATION ..... 3

INSTALLATION ..... 4

*Signal When to Monitor Heater* .....5

FIELD WIRING ..... 5

PROGRAMMING ..... 7

*Circuit Monitor Options* .....8

*Power Frequency* .....9

*Alarm Silence Time-out* .....10

*Scan Speed* .....10

*Alarm Reset Auto/Manual* .....10

*CM-1 ambient panel start-up procedures* .....12

OPERATION ..... 13

*Alarm Delay* .....14

*Alarm Silence Button*.....14

CURRENT ADJUSTMENT PROCEDURE ..... 15

*Digital Display Window*.....16

SPECIFICATIONS ..... 16

*Performance* .....16

## GENERAL INFORMATION

The Nelson CM-1 Circuit Monitor is a scanning microprocessor system which sequentially monitors and displays each circuit number and the status of each circuit.

The CM-1 is environmentally hardened and requires no protected operative environment. It can be located in a control room or out in a plant. The low voltage, optically isolated design allows the unit to be installed in Division 2 Hazardous Locations.

The CM-1 monitoring system:

- Monitors electrical characteristics of each heater circuit, including voltage, amperage, & continuity.
- Is totally passive.
- Has built in filters eliminate false alarms due to electrical noise.
- Monitors self-regulating, constant voltage, & series types of heaters.
- Independent of control scheme - will work with ambient or pipe sensed systems.
- Can be retrofitted into existing systems.

The main components of the system include:

- A microprocessor based scanner that interrogates all circuit sensor cards and compares the data to its programmed parameters. The maximum number of circuits monitored is 24.
- Sensor Card - the sensor card contains the circuitry for 4 heater circuits. Six cards are supplied in a 24 circuit system. The sensor card monitors the current and voltage to each circuit and is interrogated by the scanner.
- Display - the display shows what circuit is being monitored (.5" readouts). The status of the heater cable controller is displayed. The L.E.D. bar lights display continuity, current and voltage status of each circuit.
- Continuity Monitor Device (CMD) - parallel type cables require the attachment of a CMD at the end of each circuit. The CMD is totally passive. The microprocessor looks for the device's presence every time a parallel circuit is scanned to verify continuity of both bus wires.

# INSTALLATION

When routing conduit to the panel, avoid top entry into the CM-1 enclosure. Top conduit entry provides a potential moisture path to the electronic circuit boards. Bottom conduit entry is recommended. If top entry cannot be avoided, avoid the area directly over the circuit boards. Drip loops as shown are recommended for side and top entry when they cannot be avoided. A drip loop is a dip or bend in the circuit wire to block or shed moisture, which may follow a wire to the circuit boards.

## WARNING:

Moisture intrusion can damage the CM-1 electronic circuit boards. Do not place conduit entry directly over the circuit boards.

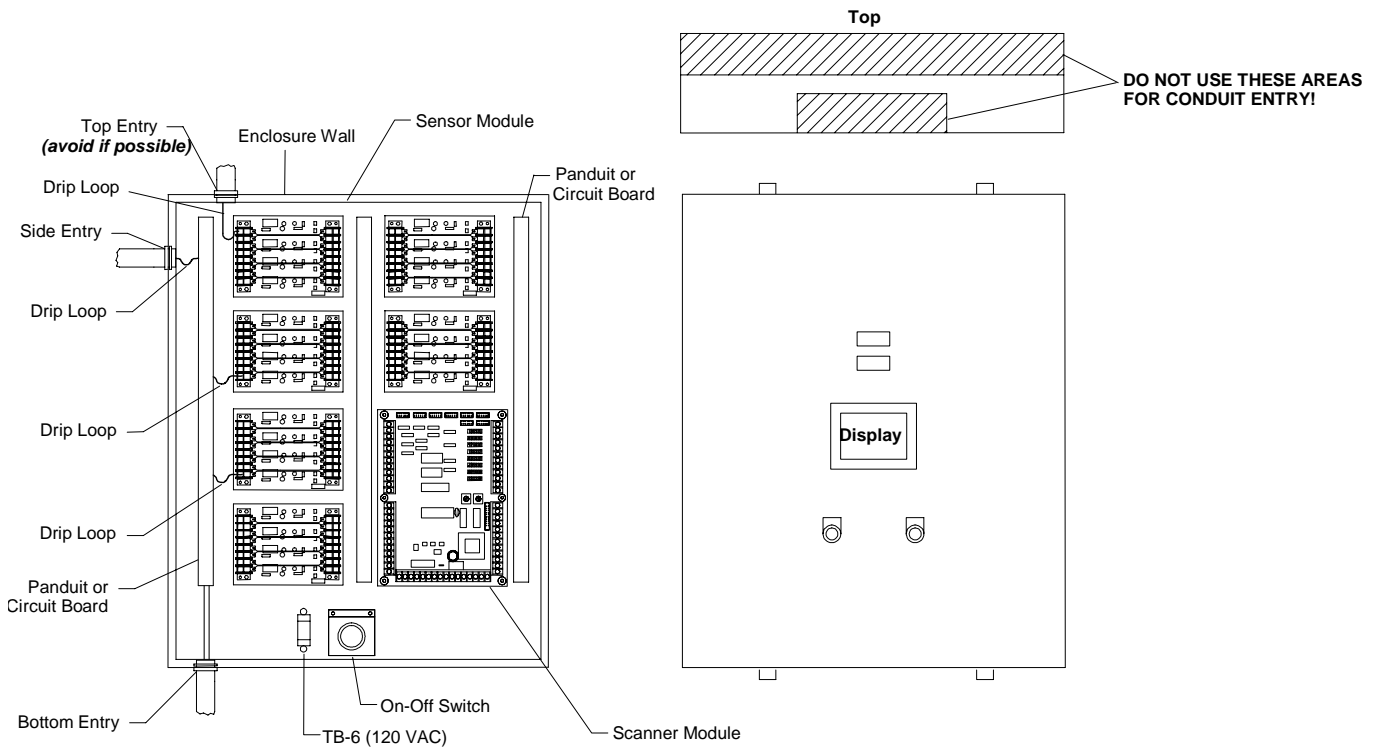

*CM-1 Conduit / Wiring Entry for Enclosure*

Figure 1

## SIGNAL WHEN TO MONITOR HEATER

The monitor looks for a closed contact signal from a temperature controller before it tries to monitor the heater for current, voltage, and continuity. The default set-up requires an input signal for each monitor channel. When a group of heater channels are controlled by a single thermostat (grouped or ambient control), the panel inputs have to wire in parallel to the single contact signal. Stamped brass jumpers are provided with the panel to reduce the wiring required for this type of connection.

## FIELD WIRING

Typical system wiring diagrams are included in this manual for field wiring. These wiring diagrams are located at the back of the manual. The PLT-CMD is used to monitor bus continuity on a parallel type heating cable. After the installing the heater cable on the pipe, connect the PLT-CMD to the opposite end of the power connection kit.

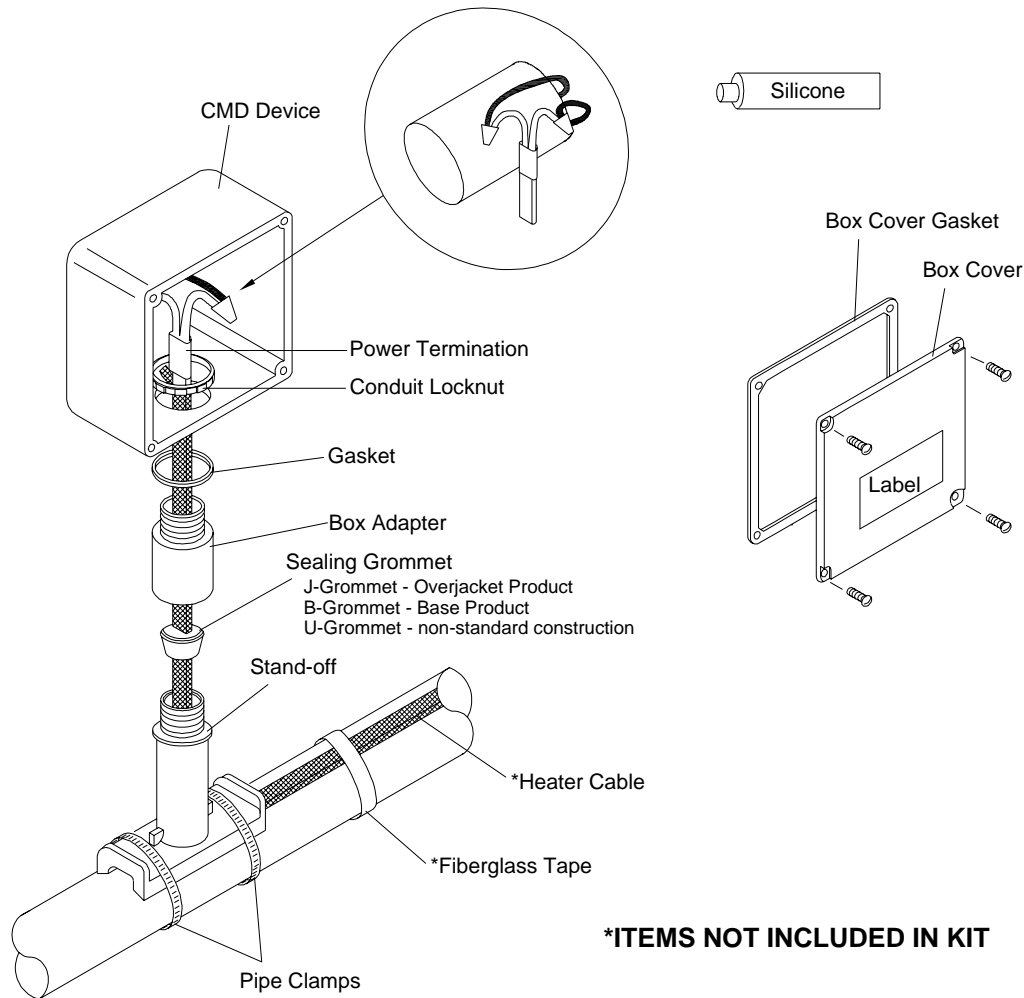

*PLT-CMD Continuity Monitor Device*



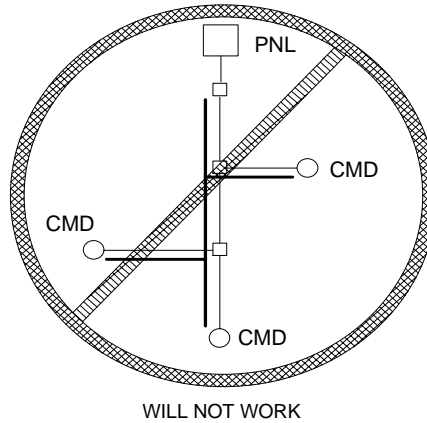
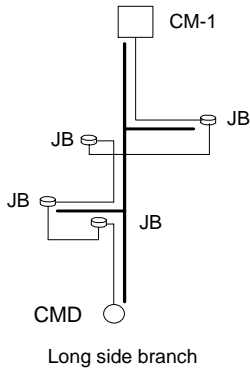
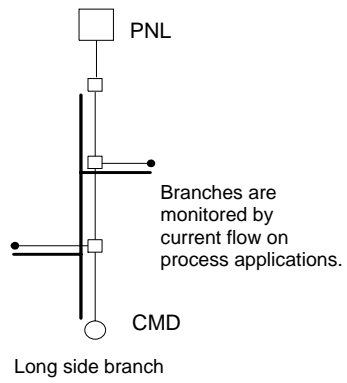
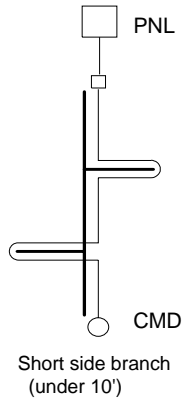

Figure 2

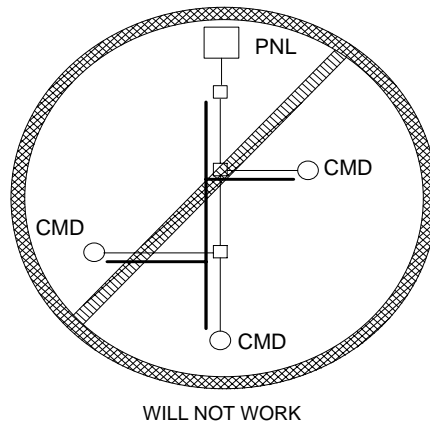
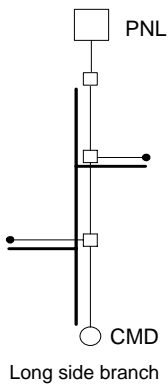

**BRANCH / TEE PIPING**  
(single circuit, multiple cable segments)



**LEGEND**

-  CM-1, CM-2/1
-  Heater Connection Kit
-  Pipe
-  Heater Cable
-  CMD

**GROUPED SEGMENTS**  
(several separate cables thru single monitor point)

*PLT-CMD Cable Connections to CM-1*

Figure 3

# PROGRAMMING

The CM-1 is shipped with programming to monitor all available circuits. With this configuration, all 24 circuits will be scanned for alarms. Alarm delay is set for 5 seconds, alarm reset is automatic, and the display speed is fast. Each of these features and options will be covered on the next few pages. However, the system is suitable to be powered in the existing configuration. When programming refer to *Figure 13*, which is also provided inside the door of the CM-1 enclosure. If all 24 circuits are not active (monitor not required) remove the corresponding programming jumper. Programming can be changed in the field by removing or adding option jumpers as needed.

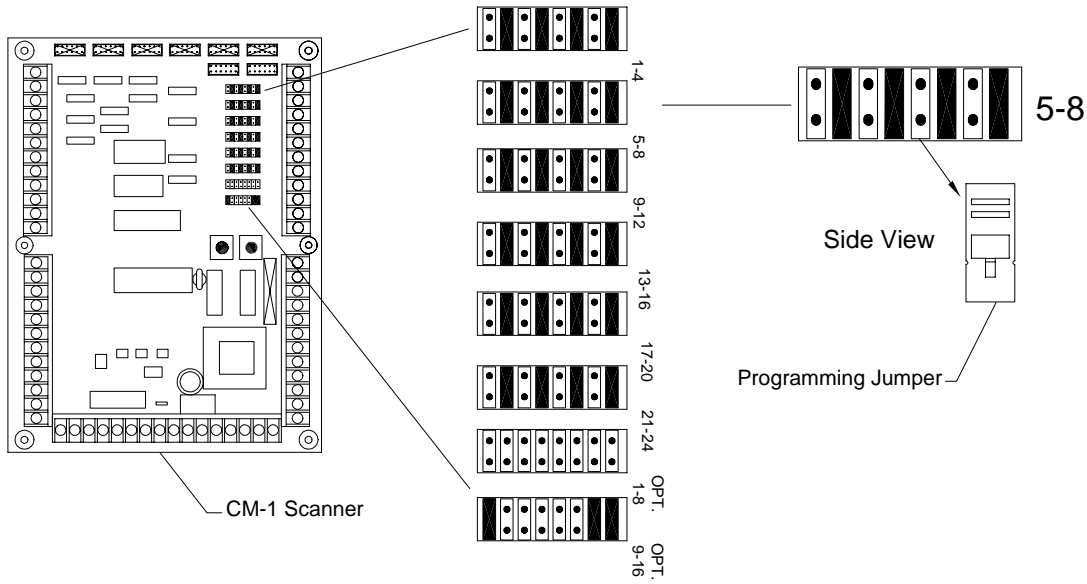
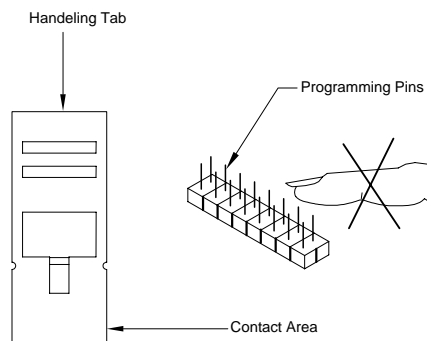

Figure 4

Programming of the CM-1 is accomplished by adding or removing the plastic program jumpers located on the scanner board.

**WARNING:**  
DO NOT TOUCH EXPOSED  
PROGRAMMING PINS.



*Programming Jumper*

Figure 5

## CIRCUIT MONITOR OPTIONS

The top 6 rows of option jumpers in the jumper programming area are the circuit monitor jumpers. As the system is shipped, all circuits available in the system will be monitored, or “active”. If a circuit is deactivated, remove the appropriate programming pin, and the circuit will be skipped in the monitor sequence. The mode jumper is left in place if a CMD is used, (parallel heaters) in the circuit.

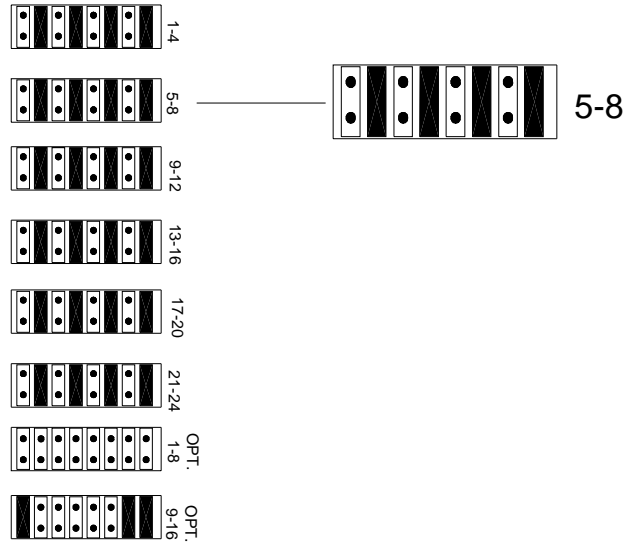

Figure 6

### *Examples:*

If circuit #6 is to be deactivated, remove this jumper. This circuit will not be scanned or monitored until the programming pin is replaced.

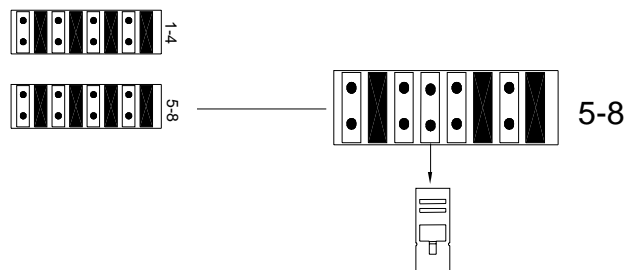

Figure 7



If circuit #5 is not going to use a CMD, move this jumper to the Left or "A" position.

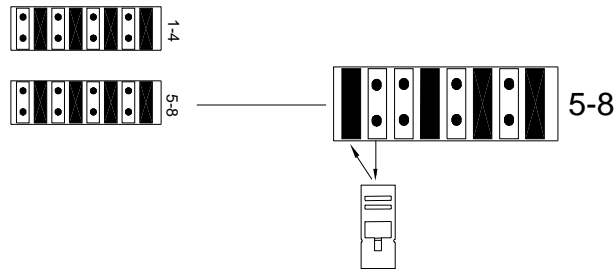

Figure 8

### POWER FREQUENCY

As shipped from the factory, the system is suitable for 60 Hz. If 50 Hz is required, a jumper must be placed on option #8 programming pin.

Open for 60 Hz –  
Closed for 50 Hz

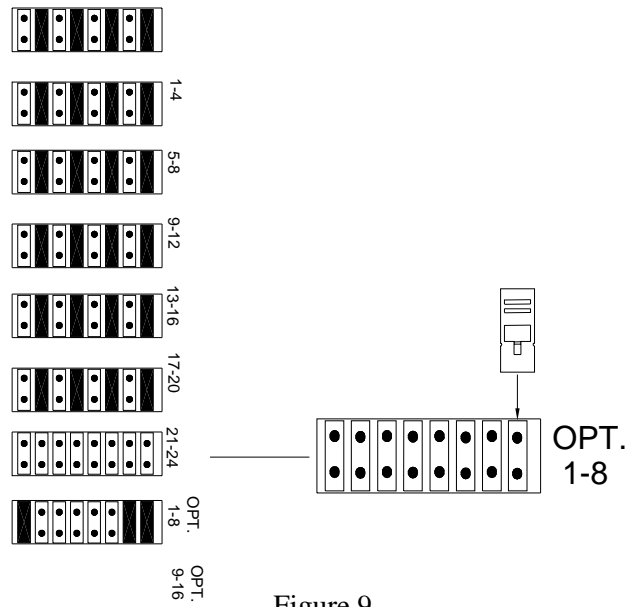

Figure 9

## ALARM SILENCE TIME-OUT

This establishes the amount of time the acknowledged alarm is silenced before re-alarm. If an alarm is acknowledged (which silences the remote alarm relay), and the voltage problem is not corrected, the system will re-activate the remote alarm relay.

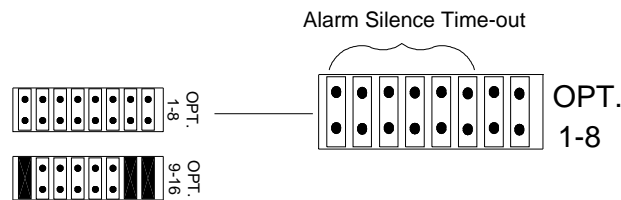

Figure 10

## SCAN SPEED

This is a customer preference option. Recommended practice is to leave this jumper on fast scan (option pin #16), for installation and set up. Remove for slow scan (jumper pin #16), during normal operation.

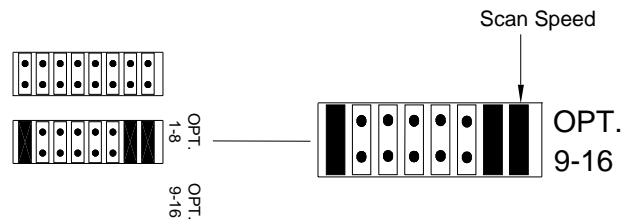

Figure 11

## ALARM RESET AUTO/MANUAL

In auto reset mode, (pin installed): The alarm status and remote alarm will clear automatically when a circuit fault clears. In manual mode, (pin removed): When a fault is cleared, both the scanner display and the remote output will remain in alarm until the reset button is pressed.

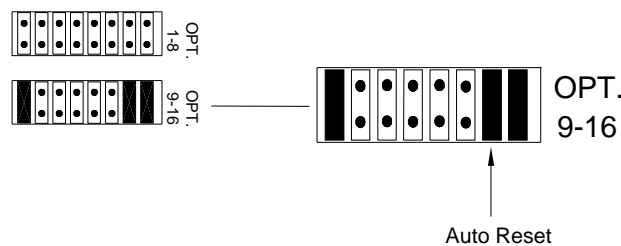

Figure 12

*Note: After any change in the system program, press the "Alarm Reset" button on the front of the enclosure. This will reset all options and finalize any changes that have been made by adding or removing programming pins.*

TYPICAL FOR ALL CKTS.

OPTION PINS LOCATED ON  
SCANNER BOARD GC0698

CIRCUIT MONITOR OPTION  
(EXAMPLE FOR CIRCUIT 1)

1-S: OPEN }  
1-P: OPEN } MONITOR TURNED OFF

1-S: JUMPER } MONITOR FOR  
1-P: OPEN } SERIES HEATER

1-S: OPEN } MONITOR FOR  
1-P: JUMPER } PARALLEL HEATER\*

\*PARALLEL HEATER CONTINUITY MONITORING

TO MONITOR BUS CONTINUITY WITH  
THIS UNIT, A CONTINUITY MONITOR  
DEVICE (CMD) MUST BE ATTACHED  
TO THE FAR END OF EACH PARALLEL  
HEATING CABLE AFTER IT IS INSTALLED.

DISPLAY 25-48

OPEN: 1 THRU 24  
JUMPER: 25 THRU 48

OPEN: 60 HZ.  
CLOSED: 50 HZ.

REFLASH TIME

(BEFORE RENUNCIATION) IN HOURS  
(TIMEOUT IS 24 HRS. IF NO JUMPERS)

DISPLAY SPEED  
OPEN: SLOW (NORMAL)  
JUMPER: FAST

ALARM RESET

OPEN: EXTERNAL RESET  
JUMPER: AUTO RESET  
(ALARM RESETS WHEN FAULT CLEARS  
OR WHEN THERMOSTAT OPENS)

ALARM TIMEOUT

(TIMEOUT IS 5 MIN. IF NO JUMPER)  
THIS IS AN ALARM DELAY TO PREVENT TRANSIENT CONDITIONS,  
THAT OCCUR DURING HEATER LOAD SWITCHING,  
FROM TRIGGERING FALSE ALARMS.  
A 5 MIN. TIMEOUT SHOULD BE USED FOR  
SELF-REGULATING HEATER CABLES.

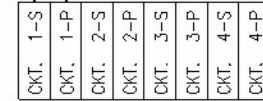

1-4



5-8



9-12

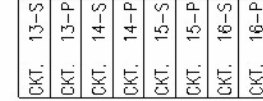

13-16



17-20

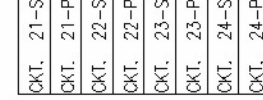

21-24

CIRCUIT SELECTOR PINS



1-8

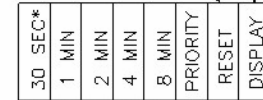

9-16

OPTION PINS

OPEN: THERMOSTAT PRIORITY  
JUMPER: VOLTAGE PRIORITY, USE  
WITH ELECTRONIC THERMOSTATS

**PROGRAMMING OPTION FEATURES**  
**NELSON CABLE MONITOR**  
**CAT. CM-1**

GA-2127

Figure 13

## CM-1 AMBIENT PANEL START-UP PROCEDURES

1. Always use caution when energizing heater cables especially when the ambient temperature is above 50°F.

Start-up requires that the cables be energized. One way to accomplish this is to set the panel thermostat to a temperature above the current ambient air temperature until start-up is completed.

2. Make sure the heat tracing circuit breakers are in the on position and allow the heater cables to be energized for 30 minutes.
3. Check the CM-1 alarm display on the front of the CM-1 panel for any alarms. If any alarms are indicated use the alarm trouble-shooting guide included with these instructions to resolve each alarm one by one.

Current alarms can sometimes be resolved by adjusting the current sensing trimpot located on the sensor card using the "Current Adjustment Procedure" section in the CM-1 manual. Press the <Alarm Reset> button on the CM-1 panel to verify all alarms.

4. If an alarm is still present after troubleshooting the circuit, check the CM-1 jumper pin configuration using the CM-1 manual. The jumper pin configuration allows the CM-1 to monitor both self-regulating and series resistance heater cables.

Each circuit must be configured according to the type of cable being used. Use the CM-1 manual to check for the correct jumper pin configuration for each circuit.

5. Using the current trimpot adjustment procedure from the CM-1 manual adjust the current trimpot for each circuit.
6. Reset the ambient thermostat to the correct maintain temperature.
7. Heater cable testing and trouble-shooting guides are available to assist in resolving alarms.

## OPERATION

After the installation and programming is completed and 120VAC have been applied to the TB-1, turn the power switch to "ON". See *Figure 1*.

For a moment both the red and green L.E.D. bars will light, then the system will start scanning. The green light bar will always appear under each active circuit, the first scan after powering up or resetting alarms. The green bars will continue to appear under the circuit number until the thermostat turns the heater off, or a loss of voltage occurs, or continuity is lost, or amperage drops below the threshold. After the alarm delay time-out, the red bar will light up and the remote alarm will energize. This alarm condition will continue until the problem is fixed, and the alarm reset switch is pressed, if the system is in manual reset mode.

### **WARNING:**

During normal operation of the system, the cabinet door will not need to be opened. Therefore, keep the door closed and completely fastened to protect the electronic from dirt and moisture.

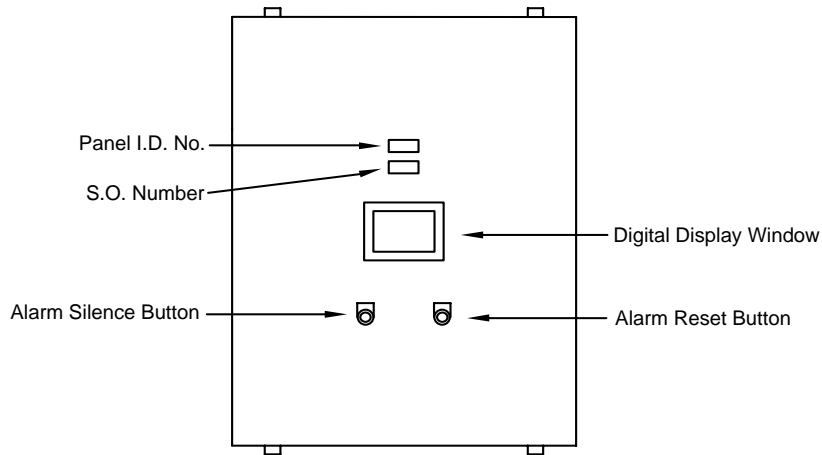

*CM-1 Panel Enclosure*

Figure 14

## ALARM DELAY

This is a customer preference option. This option establishes the minimum time delay before a loss of voltage condition is registered by the scanner. The option range is from 30 seconds to 5 minutes. Times shown are in seconds and minutes and are additive. A longer time is recommended to prevent alarming of temporary power interruptions.

### **Example:**

For a 2 1/2 minute delay; place jumpers on the 30 second and 2 minute pins:

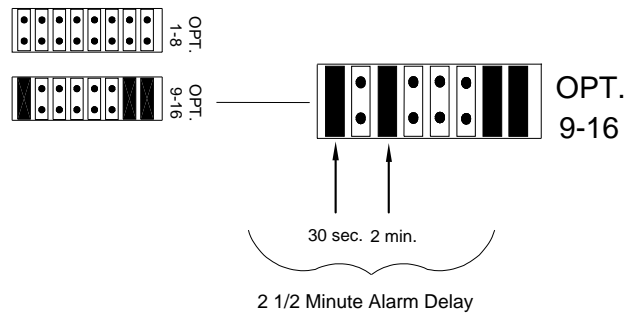

Figure 15

## ALARM SILENCE BUTTON

This button will temporarily silence the remote alarm (up to 24 hours depending on the program pins; see the Programming section for “Alarm Silence Time-out”). While corrective actions are being taken on failed circuit(s) the alarm will re-enunciate if a new circuit fails when the system is silenced. Pressing the “Alarm Silence Button” will silence the remote alarm relay and reset the timer.

When voltage has been restored to all of the failed circuits, press the “Alarm Reset” button to clear all alarms from the system if the “Manual Reset” has been selected.

## CURRENT ADJUSTMENT PROCEDURE

The CM-1 sensor card has an adjustable current alarm. The current adjust feature works with all types of heater cables; self-regulating, constant wattage and MI. The sensor cards come from the factory preset to a minimum current alarm level of 50 milliamps. Current flow above the minimum threshold is indicated by a red L.E.D. located on the sensor card by each circuit.

- 1) Each circuit must be individually adjusted under operating load conditions. Circuits are sequential, starting with circuit No. 1 on sensor card M1. There are four circuits per sensor card.
- 2) Apply power to first circuit to be calibrated. Be sure that the thermostat contacts are calling for heat. This may require that you temporarily adjust the thermostat set-point higher to get the unit to close, if you do, **BE SURE TO RETURN IT TO THE PROPER SET-POINT AFTER CALIBRATION.**
- 3) At this point the circuit to be calibrated should be indicating "HEATER ON" (green light ON). Some heater cables have a higher inrush current when first turned on. **ALLOW HEATER TO OPERATE NORMALLY FOR 24 HOURS BEFORE STARTING CALIBRATION OF CURRENT ALARM.**
- 4) Locate the sensor card's current trimpot for the circuit to be calibrated. The trimpot is a blue 13mm x 19mm (0.5" x 0.75") device with a brass adjusting screw located about 25mm (1.0") to the left of the Load Terminal Strip. See Figure 17 for red L.E.D. and the adjustment trimpot located for each.
- 5) Turn adjusting screw clockwise with an **INSULATED SCREWDRIVER** until the red L.E.D. dims. With the L.E.D. turned off the circuit is in **ALARM**.
- 6) Turn adjusting screw counter clockwise until the red L.E.D. comes fully ON. The circuit is now out of **ALARM** and calibrated for the existing voltage and temperature conditions.

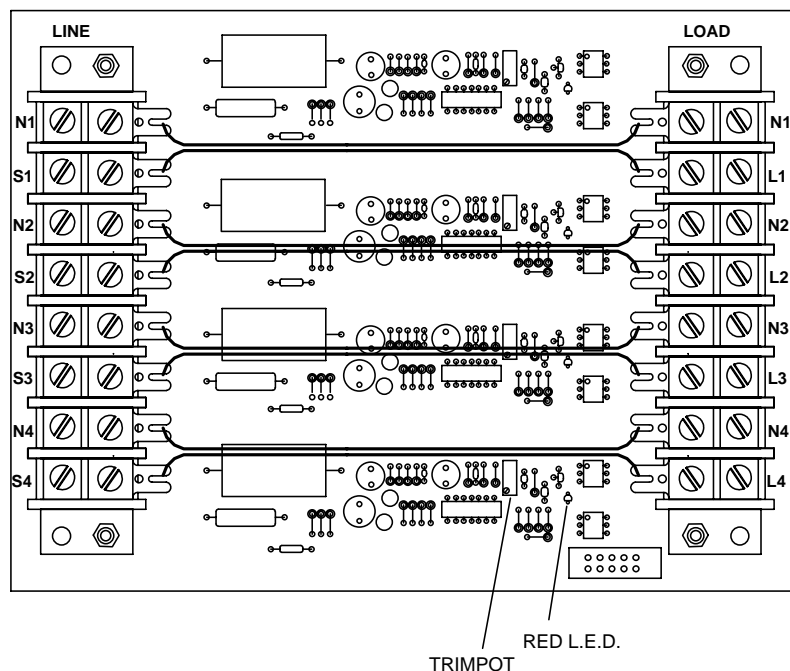
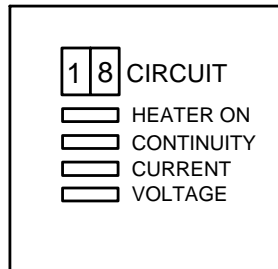

Figure 16

## DIGITAL DISPLAY WINDOW

The circuit numbers being scanned by the system are displayed here in the status area.



*Monitor Display*

Figure 17

### Conditions:

- 1) No light bar energized below the circuit number indicates the circuit is de-energized. This is a non-alarm condition.
- 2) The green light bar energized indicates that the circuit is energized and functioning satisfactorily. This is a non-alarm condition.
- 3) **Voltage** - the (red) indicator energized indicates that voltage is not present when the circuit should be energized. This is an alarm condition.
- 4) **Current** - the (red) indicator energized indicates that current flow has dropped below the adjustable level set on the sensor card. The minimum level is 50mA, the maximum is 30A. This would indicate an open circuit on a series heating cable. On parallel cables this would indicate a possible break in the power wiring between the heater cable power termination and the CM-1 panel or the failure of a portion of the parallel heating cable.
- 5) **Continuity** - the (red) indicator energized would indicate a loss of continuity in the bus wires of a parallel heater cable.

## SPECIFICATIONS

### PERFORMANCE

Ambient Temperature:	-40° to +130°F
Power Input:	120VAC; 1A
Heater Voltage Range:	85VAC to 300VAC
Amperage Range:	0.05 to 30.0A
Relative Humidity:	0-95% max. non-condensing boards are conformal coated and gold plated connectors are used.
Hazardous Locations:	Approved for Class I, Division 2, Groups A, B, C, & D; Class II, Groups F & G; Class III, Div. 1 & 2.
Alarm Output:	Solid State output; 120V AC/DC @ 100ma max. Optional relay with dry contact available. Output is energized during normal operation.
Display:	Scanner - Single line numeric L.E.D. Alarm - L.E.D. bar indicators for voltage, current, and continuity.





---

Nelson Heat Tracing Systems products are supplied with a limited warranty. Complete Terms and Conditions may be found on Nelson's website at [www.nelsonheaters.com](http://www.nelsonheaters.com).